

Description

Mini pool swim spa

5900x2380xh1400 mm_Cod: AQUALISTS601T

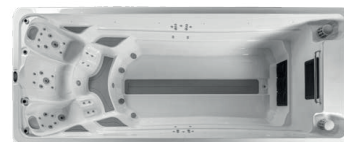

Dear user,

Thank you very much for purchasing our sanitary ware. To enable you to use this product safely and effectively, please read this installation and operation manual carefully before use.

Cautions

1. Please connect the water pipe before installed the products.
2. Please ensure that the product installed reliable electric leakage protection device, the power plug contains earth line, and make sure it is reliable earthing. Check the protect system of leakage protection each time before use.
3. Before turn on water pump, check if the water level over jets 10 to 20 mm or not, make sure regular usage of water pump otherwise it will be destroy because of water leakage.
4. Do not turn on water pump, heat pump or air bubble pump without water
5. People with Hypertension symptom, after drink or heart disease are not allowed to use this product . Children have a bath must under adult's guidance.
6. During use please noticed that don't blocked the jets . Also keep this product clean and don't let it blocked by hair or mess.
7. During use, please firstly adjust the water temperature or it will be burned.
8. The outdoor spa is designed with ergonomic, rise and fall changes are dis tiuctly, so pay more attention of slip.
9. Please shut down the system when not use.

Technical Parameter

Size: 5880x2380x1400mm

Voltage: 380V 50Hz

Hydraulic pressure : 0.1 ~ 0.2Mpa

Power of water pump : 2200 W×1 - 1500 W×1

Filter pump: 750W

Power of heater : 3000 W

Color changing light: 12V, 100mA

Cleaning and Maintenance

1. The daily maintenance of outdoor spa should be cleaned with ordinary detergent and soft cloth. Please do not use the detergent which contains acetone or ammonia liquid. If there marks or something like glue on the surface of bathtub, just polish it with soft cloth dipping with gas.
2. If there are scratches on bathtub surface, please polish it with 1500# frosted paper dipping with liquid and burnish it with toothpaste. It will be shining again after that.
3. If there are furring on the surface of bathtub, it can be take away by mild acid detergent, for example wipe the bathtub with lemon juice or vinegar which be heated.
4. Do not wipe the chrome plated spare parts all the time, and do not get in touch with chemical detergent etc. Otherwise the surface of chrome plated will be destroyed. The product should be clean by soft cloth other than coarse cloth.
5. To check the water pipe regularly in order to avoid troubles from crack of water pipes or blocked inside.
6. If there are something such as hair stuck inside the jets, then just to twist out the jets and remove it.
7. To clean hydro-massage equipment: To full fill hot water which is 40'C, and pour 2g/L detergent, start hydro-massage function more than 5 minutes, then turn off the massage function and drain out the water. Next, to full fill cold water and start hydro-massage function for 3 minutes, then turn off the massage function and drain out the water, at last, to dry the bathtub with towel.
8. Filter should be clean once a week.
9. Keep out from combustibles and goods which over 80°C to avoid fire disaster and damage the product.
10. The bathtub should be transported carefully. Do not lay heavy things on it and do not bump and shaking the tub. If the bathtub has not been used for a long time, drain out the water of the bathtub and keep it in a dry and ventilate environment. Avoid corrosive gas.

Troubleshooting

Problems	Reasons	Maintenances
No power or electricity leaking protection device is activated	<ol style="list-style-type: none"> 1.Electricity leaking protection device cut off power source when electricity line is not well connected. 2.Power or electricity circuit have phenomenon of electricity leaking. 	<ol style="list-style-type: none"> 1.check and reconnect the wiring system. 2.check the power source, electricity circuit and ground line.
Water Jets are not working.	<ol style="list-style-type: none"> 1.check the system whether is on. 2.the impeller of water pump doesn't rotate 3.water pump is broken which caused by working without water coming in. 	<ol style="list-style-type: none"> 1. turn on the system 2. check through and remove the garbage which is inside the pump. Switch pipe can be removed. 3. install a new water pump
The intensity of hydro-massage cannot be adjusted	<ol style="list-style-type: none"> 1.water pump's suction has not enough power. 2.air adjustment valve is abnormal 3.jets or nozzles are blocked 	<ol style="list-style-type: none"> 1. check the water pump whether is working normally. 2.change the air adjustment valve 3. remove things which are blocking the jets.
Water leaks from the pipes.	<ol style="list-style-type: none"> 1.seal ring is broken 2.screws doesn't lock tightly 3.pipes doesn't seal properly. 4.water pipe is broken 	<ol style="list-style-type: none"> 1.chang seal ring 2. lock the screws tightly 3. re-seal the silicone. 4. change water pipe
Control panel doesn't work	<ol style="list-style-type: none"> 1.Electricity line didn't connect to power source, electricity leaking protection device cut off power. 2.power button is not working. 	<ol style="list-style-type: none"> 1.Re-connect the power source and check the electricity leaking switch button. 2.change a new control panel <p>Lighting is off</p>
No lighting	<ol style="list-style-type: none"> 1.The bulb is broken 2. power line is disconnected. 3.control panel is broken 	<ol style="list-style-type: none"> 1.change a new bulb. 2.re-connect the circuit. 3 .maintain or change control panel
Radio is off	<ol style="list-style-type: none"> 1.speaker is broken 2. power line is disconnected. 3.control panel is broken 	<ol style="list-style-type: none"> 1.change a new speaker 2.reconnect the circuit. 3. maintain or change control panel

INSTALL SKETCH

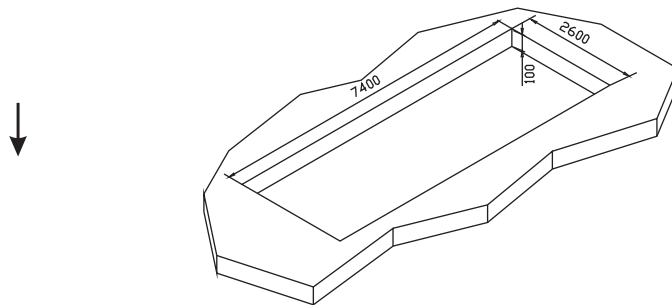

The location where to place the swimming spa should be in sunken dug pit measure: 6080mm×2580mm×100mm

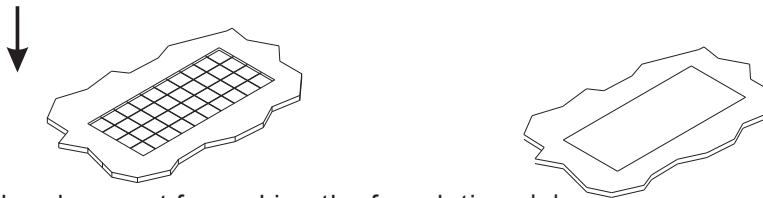

Use steel and cement for making the foundation slab

Note: Very important the foundation strength supports th

Filter Cleaning

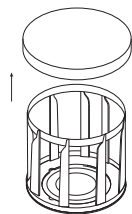

1、 take up the cover



2、 move out the cover

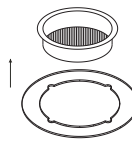

3、 pull out the skimmer basket

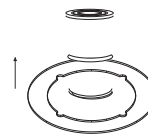

4、 Take out the filter core then clean with water or detergent

Construction Sketch

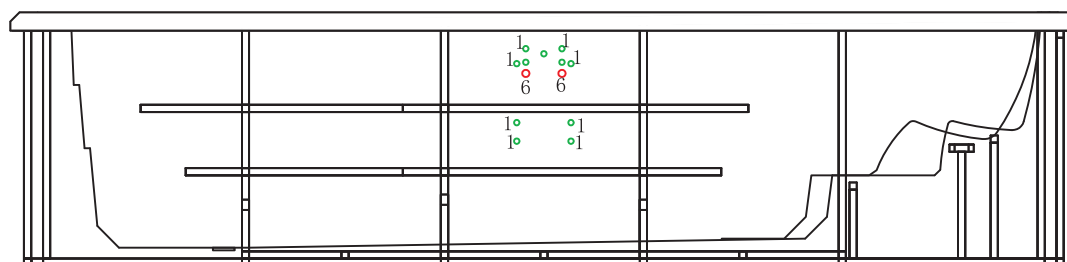
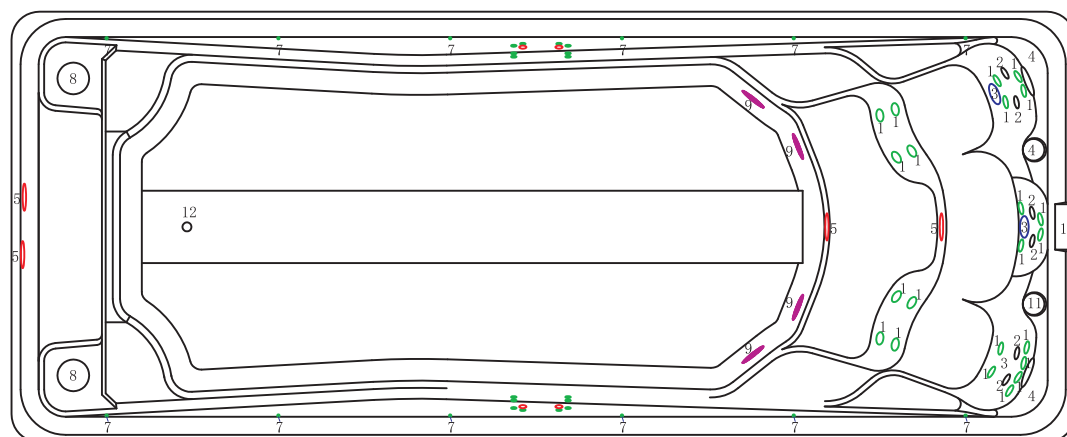

NO.	Name	Number
1	1"Jet	38
2	2.5"Jet	6
3	5"Jet	3
4	Air adjustor	3
5	Light	2
		2
6	2"Jet	4
7	Little light	12
8	Filter	2
9	Water suction	4
10	Control panel	1
11	Swim training system Control panel	1
12	Water device	1
13		

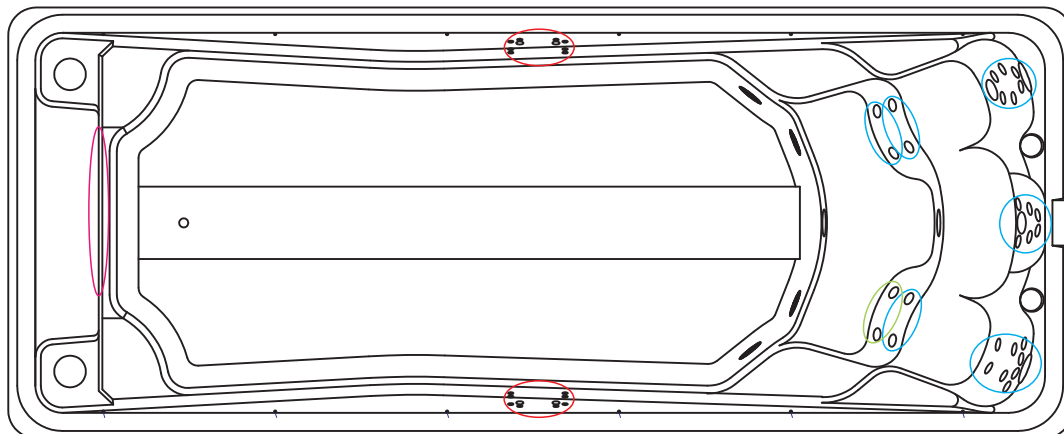

Turn on the Swim training system Press jetbutton, water will spray from ■

Turn on the control system

1. Turn the pump1, water Will spray from ■
2. Turn the pump2, water Will spray from ■
3. Turn the filter pump, water will spray from ■

