

Descrizione / Description :

Vasca con cascata Vittoria

Bathbubs with waterfall

2000x900Xh610 mm_ Cod: VIMAR20090

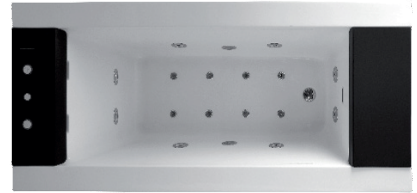

PREINSTALLAZIONE

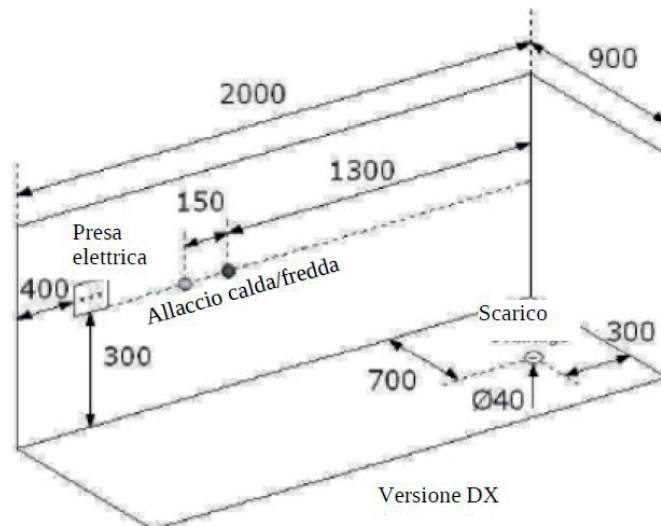
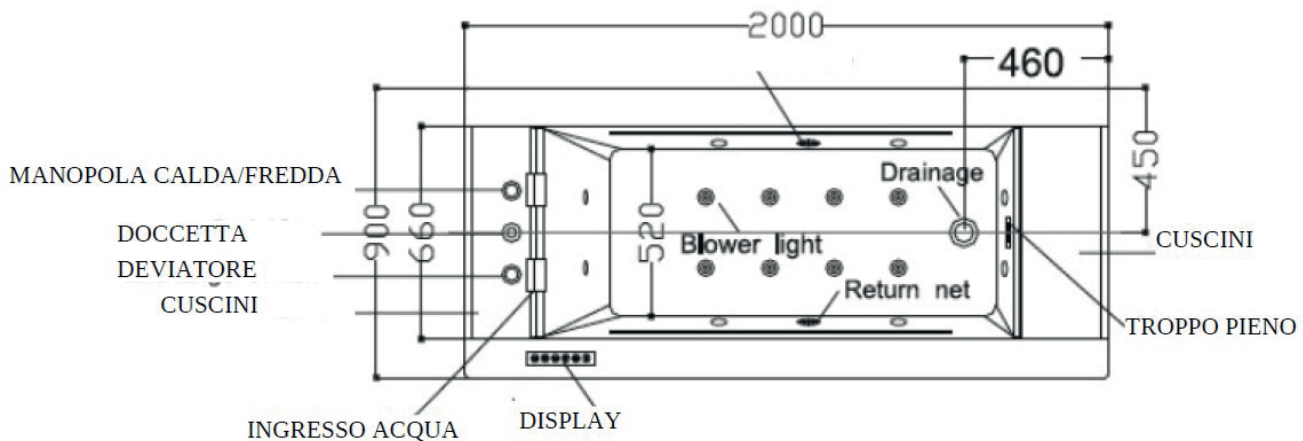
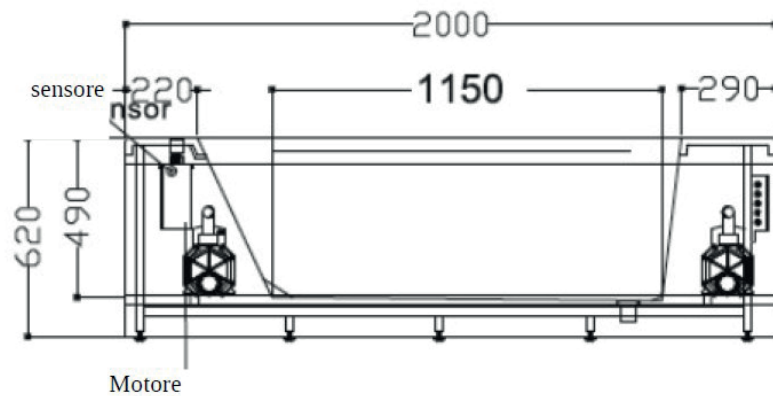

SISTEMA TOUCH RETROILLUMINATO BACKLIT TOUCH SYSTEM

Mod. ANGEL
Mod. VITTORIA

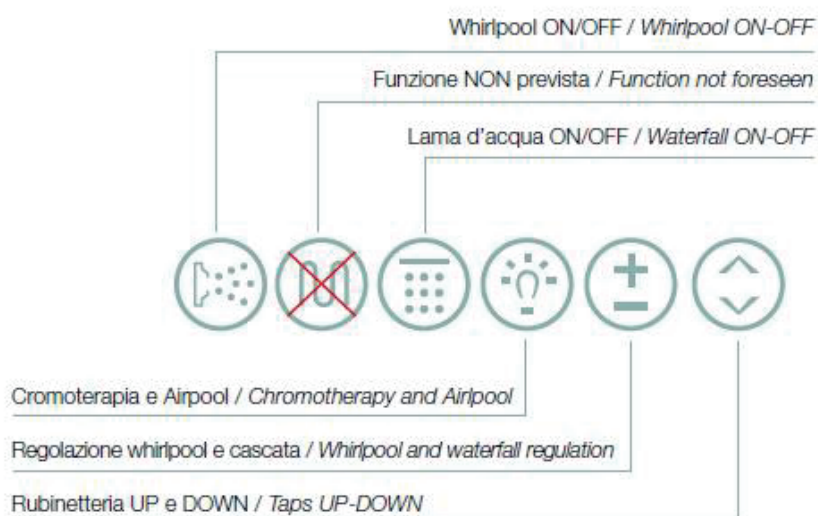

ISTRUZIONI:

Il sistema si accende grazie ad un sensore di movimento posto sul frontale della vasca.
Affinché l'idromassaggio si accenda è necessario che l'acqua raggiunga il corretto livello.

Idromassaggio:

Per accendere l'idromassaggio premere il tasto WHIRLPOOL. Premere ancora per spegnere.

Cascata

Premere il tasto CASCATA per attivare la stessa. Premere ancora per disattivare.

Con il tasto + e - si può modulare il getto.

Airpool:

Tenere premuto il tasto Cromoterapia per accendere la soffiante.
Tenere ancora premuto per disattivare la stessa.

Cromoterapia:

Premere con un leggero tocco il tasto Cromoterapia per accendere le luci.
Premere una seconda volta per spegnere le stesse.

Rubinetteria:

Premere il tasto UP/DOWN per estrarre la rubinetteria. Premere ancora per riporlo nel suo alloggiamento.
n.b.: Prima di aprire l'erogazione, accertarsi che il deviatore sia sul canale giusto.

Altrimenti si rischia di aprire acqua sul doccino
mentre lo stesso è riposto con la conseguente fuoriuscita d'acqua.

1、Electricity parameter

Rated voltage	Rated power	Rated electric current	Reference circuit voltage
220VAC	1850W	<4A	12V

2、Electric installation

- 2.1 power supply's establishment should be complied with nation security standard, voltage and frequency also should be accord with product's nameplate. Especially install creep-age protect switch and also check whether can connect with ground.
- 2.2 The wire collected to the massage bathtub should be fitting permanent., and the wire should be a three-core wire, the sectional acreage of each core cannot less than 12A. when wire pass the wall, it should be use bushing for protection until the AC outlet.
- 2.3 Ground wire of bathtub should be test whether works with house appliance ground wire.
- 2.4 The wire end of electricity control box should connect to the control panel, water bottom light, loudspeaker, electrical engineering and the detector protection respectively.

3、Water supply device

- 3.1 This device's hydraulic pressure is 0.2-0.4Mpa.
- 3.2 The water supply characteristics on the wall: The cold or hot water supplies inside the bathroom also establish in the shelter of the massage tub, use the hose to connect with the cold or hot joint of the tub. the pipe towards is decide by the customer, the machine do not go with the hose
- 3.3 Please use living water which PH is about 6.5 to 9.5.

4、Installation introduction

- 4.1 Before install, must consider the place of install massage bathtub whether can support this device's pressure.
- 4.2 Place the massage bathtub on the install position, adjust level to make the drain system smooth.
- 4.3 Adjust the leg's screw to make sure all of the screw touch ground completely.
- 4.4 Install the drain hose, and make some measure to against on the connecter.
- 4.5 Fix cold and hot water-pipe well, then install the showerhead. And then put drain into downcomer, finally connect with power and make sure whether device connected with ground can work.

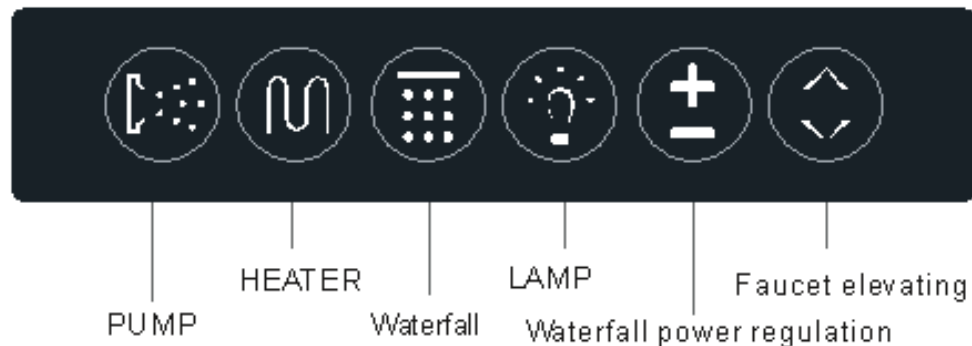



5. OPERATING INSTRUCTION:

Induction-type motion sensor: When the control panel is off, it will light up again by detection of the human body infrared sensor as long as the user approaches.

Pump surfing function: There is a function of water shortage protection. The highness of the water in the bathtub must meet the standards in order

to start the pump. Press () key to start the pump and shut down. The pump will automatically shut down after working 60 minutes every time.

Air bubble function: Press () for 3 seconds then air bubble can work (Special notes: This means a feature requires an optional accessory.)

Waterfall function: Press () button, another water pump starts, then the waterfall starts, and will automatically shut down after working 60 minutes every time or click it to stop.

Waterfall and needle nozzle massage transformation: Pressing () waterfall and needle nozzle massage transform automatically. Pressing

() for several seconds can adjust the waterfall and needle nozzle massage. When waterfall power is at the maximum power, the needle nozzle massage power is off, vice versa. Or let the both kinds of massage work together. Let go can stop changing at where the user wants to stop.

1. Functions (WS-04)

NO.	Functions	Available
1	Touch sensitive control panel	✓
2	whirlpool massage function	✓
3	Waterfall function	✓
4	Air bubble	*
5	color light	✓
6	Auto drainage	✓
7	Auto ozone	*
8	Heater	*

Remark : the function with "✓" means the standard function, and the function with "*" means the optional function.

2. SPECIFICATIONS:

- Power supply : AC 220V 10% 50-60Hz
- Pump load ① : AC 220V 750W
- Pump load ② : AC 220V 750W
- Under water lamp load: AC 12V 10W
- Heater power : AC 220V 2000W
- Faucet Lamp load : AC 12V 10W
- Jacking motor: AC 12V 40W
- Waterfall Magnetic valve : DC 12V 30W
- Drainage Magnetic valve: DC 12V 10W
- Dielectric strength : 1500V/5MA 1min
- Leak current : <0.25mA
- Waterproof grade : IPX4

III. CIRCUIT DIAGRAM:

